

Kodak

i9600 Series Writers

User's Guide

A-61058
Part No. 3E9011
CAT No. 134 1759

Important Safety and Regulatory Information

IMPORTANT: *Equipment shall be installed by qualified personnel.*

WARNING: TO PREVENT FIRE OR SHOCK HAZARD, DO NOT EXPOSE UNIT TO RAIN OR MOISTURE. TO PREVENT POSSIBILITY OF INJURY OR DAMAGE TO THE UNIT, DO NOT OPERATE WITH ANY COVERS OR PANELS REMOVED.



The exclamation point within an equilateral triangle is intended to alert the user to the presence of important operating and maintenance (servicing) instructions in the literature accompanying the appliance.

Le point d'exclamation dans un triangle équilatéral avertit l'utilisateur de la présence d'instructions importantes de fonctionnement et de maintenance (entretien) dans la brochure accompagnant l'appareil.

Das Ausrufezeichen in einem gleichseitigen Dreieck weist den Benutzer in der Dokumentation auf wichtige Bedienungs- und Wartungsanweisungen in Bezug auf das Gerät hin.

Il punto esclamativo all'interno del triangolo equilatero avverte della presenza di importanti istruzioni per il funzionamento e la manutenzione contenute nella documentazione allegata al dispositivo.

El signo de exclamación dentro del triángulo equilátero pretende alertar al usuario acerca de la existencia de importantes instrucciones de operación y mantenimiento (servicio) en la documentación que acompaña al producto.

User Precautions

Users and their employer need to observe the common sense precautions applicable to the operation of any machinery. These include, but are not limited to, the following:

- Do not wear loose clothing, unbuttoned sleeves, etc.
- Do not wear loose jewelry, bracelets, bulky rings, long necklaces, etc.
- Hair length should be kept short, using a hair net if needed, or tying long hair up in a bundle.
- Remove all other loose objects from the area that could be drawn into the machine.
- Take sufficient breaks to maintain mental alertness.

Supervisors should review their practices and make compliance with these precautions a part of the job description for operation of the *Kodak* i9600 Series Writers or any mechanical device.

ElectroMagnetic Compatibility Statements

For the United States

This equipment has been tested and found to comply with the limits for a Class A digital device, pursuant to part 15 of the FCC rules. These limits are designed to provide reasonable protection against harmful interference when the equipment is operated in a commercial environment. This equipment generates, uses and can radiate radio frequency energy and, if not installed and used in accordance with the instruction manual, may cause harmful interference to radio communications. Operation of this equipment in a residential area is likely to cause harmful interference in which case the user will be required to correct the interference at their own expense.

For Japan

This is a Class A product based on the standard of the Voluntary Control Council for Interference by Information Technology Equipment (VCCI). If this equipment is used in a domestic environment, radio disturbance may arise. When such trouble occurs, the user may be required to take corrective action.

この装置は、情報処理装置等電波障害自主規制協議会（VCCI）の基準に基づくクラスA情報技術装置です。この装置を家庭環境で使用すると電波障害を引き起こすことがあります。この場合には使用者が適切な対策を講ずるよう要求されることがあります。

Taiwan

WARNING: This is a Class A product. In a domestic environment this product may cause radio interference in which case the user may be required to take adequate measures.

警告使用者：

這是甲類的資訊產品，在居住的環境中使用時，可能會造成射頻干擾，在這種情況下，使用者會被要求採取某些適當的對策。

IMPORTANT:

Compliance with regulations governing radio frequency emissions requires that the installation of your *Kodak* i9600 Series Writer use the shielded data cable provided. Any data cable the user may choose to substitute also must be shielded to assure continued compliance.

Environmental Information

- The *Kodak* i9600 Series Writers are designed to meet worldwide environmental requirements.
- Guidelines are available for the disposal of consumable items that are replaced during maintenance or service; follow local regulations or contact Kodak locally for more information.
- The *Kodak* i9600 Series Writers contain lead in the solder on the circuit boards. Lead is considered a hazardous waste and proper disposal procedures should be followed. Also the film cassette and 100 printed circuit board contain lithium batteries. For disposal or recycling information, contact your local authorities (or the Electronics Industry Alliance; www.eiae.org).
- The product packaging is recyclable.
- Parts are designed for reuse or recycling.

Acoustic Noise

Acoustic Noise Level (sound power levels [L_{wa}])

Operating Status	Noise Level dB (A)
Standby	33 db (A)
Operating	50 dB (A)

NOTE: All data measured in accordance with DIN 45 635, ANSI S12.10-1985, and ISO 7779 in a hemi-anechoic chamber.

Safety, Regulatory Conformance and Certifications

The *Kodak i9600 Series Writers* conform to all applicable national and international product safety and electronic emission regulatory requirements. This includes, but is not limited to, the following:

- UL-1950 3rd Edition
- CUL (CSA 22.2 No. 950 3rd Edition, UL-1950 3rd Edition)
- TUV / GS Mark EN 60950 with A1, A2, A3, A4, A11
- C – Tick Mark
- EN 55024 ITE Immunity
- EN 55022 ITE Emissions, Class B
- US - CFR47, part 15, FCC Class A
- Canada - ICES 003, Issue 3, Class A
- Japan - VCCI Class A
- Taiwan - CNS 13438 Class A
- Australia / New Zealand - AS/NZ 3548 Class A
- CE Mark
- Certifying Body Certificate

Getting Technical Support

If you experience problems with your system, contact the Integrator or Kodak Response Center at one of the following telephone numbers:

Within New York State: 1-800-462-6494

Outside New York State: 1-800-822-1414

Alaska and Hawaii: 1-800-466-1414

For other countries, contact your local Kodak Service Support Center.

When contacting Technical Support, be prepared to supply the following information:

- The names and models of the computer and the i9600 Series Writer you are using.
- Any memory-resident software installed, including memory managers, with version numbers.
- Any resident anti-virus software.
- Contents of the error log file.
- Any information and the action taken that can reproduce the problem you experienced. Include the exact text of any error messages you received.

Table of Contents

1 Introduction	1-1
Features	1-1
System overview	1-2
Views.....	1-3
Status/message display.....	1-4
2 Getting Started	2-1
Powering up and initializing the Writer.....	2-1
Archive Storage media cassettes	2-2
Loading media into a cassette	2-4
Loading cassette(s) into the Writer.....	2-9
Updating the cassette memory.....	2-10
Replacing the media cassette battery	2-11
3 Operating the Writer	3-1
Before you begin	3-1
Operating icons	3-1
Available functionality	3-2
On-line mode	3-2
Off-line mode	3-3
Using the functions.....	3-4
On-line/off-line	3-4
Advancing the film by a fixed amount	3-4
Making a leader.....	3-6
Tensioning the film	3-7
Running the film to the end.....	3-10
Viewing error messages	3-12
Setting the audible alarm.....	3-14
Setting the contrast.....	3-16
Diagnostics	3-18
Powering down.....	3-18
4 Troubleshooting	4-1
Error messages	4-1
Problem solving chart	4-8

1 Introduction

The *Kodak* i9600 Series Writers provide the capability of writing digital images to archive media. Image files are accepted from a host system, decompressed, composed along with image marks and optional frame annotation, and converted to analog format. The resulting images are written to *Kodak* Reference Archive Media.

Two models are available:

- *Kodak* i9610 Writer: writes at 4800 scan lines per second.
- *Kodak* i9620 Writer: writes at 9600 scan lines per second.

Features

Kodak i9600 Series Writers provide the following:

- Quick and easy filming
- Filming of bi-tonal digital images for long-term archival storage
- Accepts standard TIFF images (Tagged Image File Format)*
- Accepts Group III, Group III 2-dimensional, Group IV, and JBIG compression types
- Scales images from 20:1 to 60:1 reduction ratio
- Writes one or two rolls concurrently
- Accepts mixed image sizes
- Films in simplex, duplex, and 2-up formats
- Provides image marks and frame annotations
- Assigns image addresses for image indexing
- Provides audible and visual alarms
- Provides the ability to make a film leader
- Allows for manual film advance or run-to-end of film
- Displays the film remaining in one or both storage media cassettes
- Indicates the device is busy (image being filmed) or idle
- Intelligent energy control — after a period of no use, the Writer can automatically switch to an idle state. The actual power consumed drops to less than 5% full power

* Does not accept tiled and multi-stripped images.

System overview

The *Kodak* i9600 Series Writers rapidly convert digital image documents to human-readable images on archive media for long-term storage and access.

The Writer and its associated components (Reference Archive Capture Subsystem) are listed below:

- *Kodak* i9600 Series Writer.
- The application software simplifies integration with digital document systems.
- Customer-provided, network-ready host PC.
- *Kodak Imagelink* Smart Cassette 100 or 215 provides easy loading of *Kodak* Reference Archive Media.
- *Kodak* Reference Archive Media is a 16 mm microfilm specially optimized for the i9600 Series Writer. The standard 215-foot roll length provides an uninterrupted and unattended writing session. The *Kodak* Reference Archive Media provides ALLM/ANSI-compliant image storage that meets archival standards. Stored images can be accessed by automated retrieval devices, including the *Kodak* i7300 Scanner, *Kodak Digital Science* Intelligent Microimage Scanner and *Kodak Imagelink* Digital Workstation 2000, and scanned for electronic delivery back to your digital document system.

Views

The front and rear views shown below illustrate exterior components of the Writer:

Front View

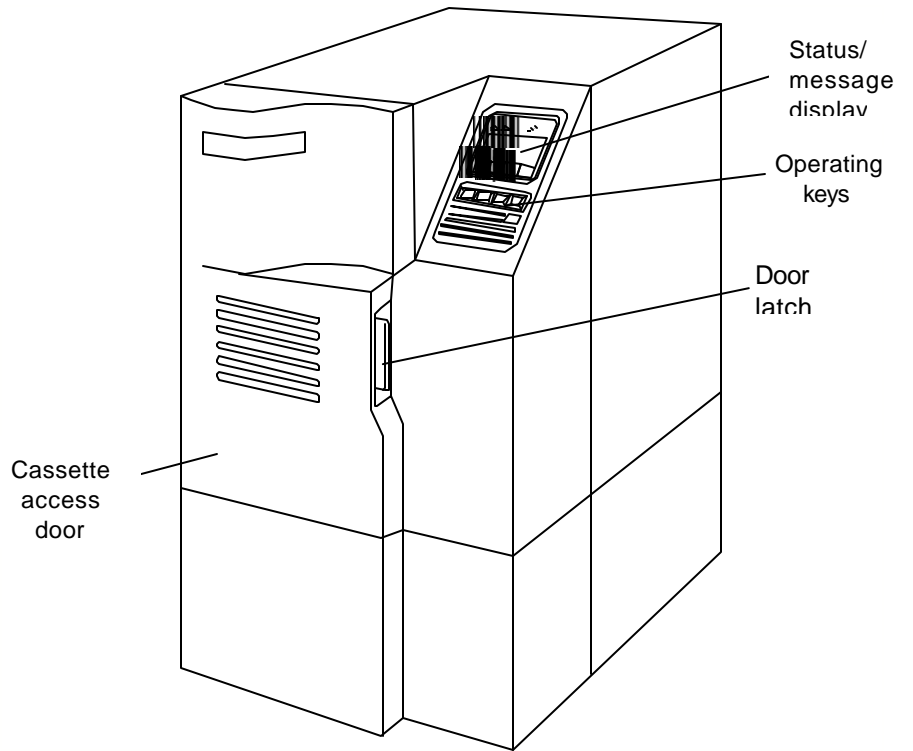

Rear View

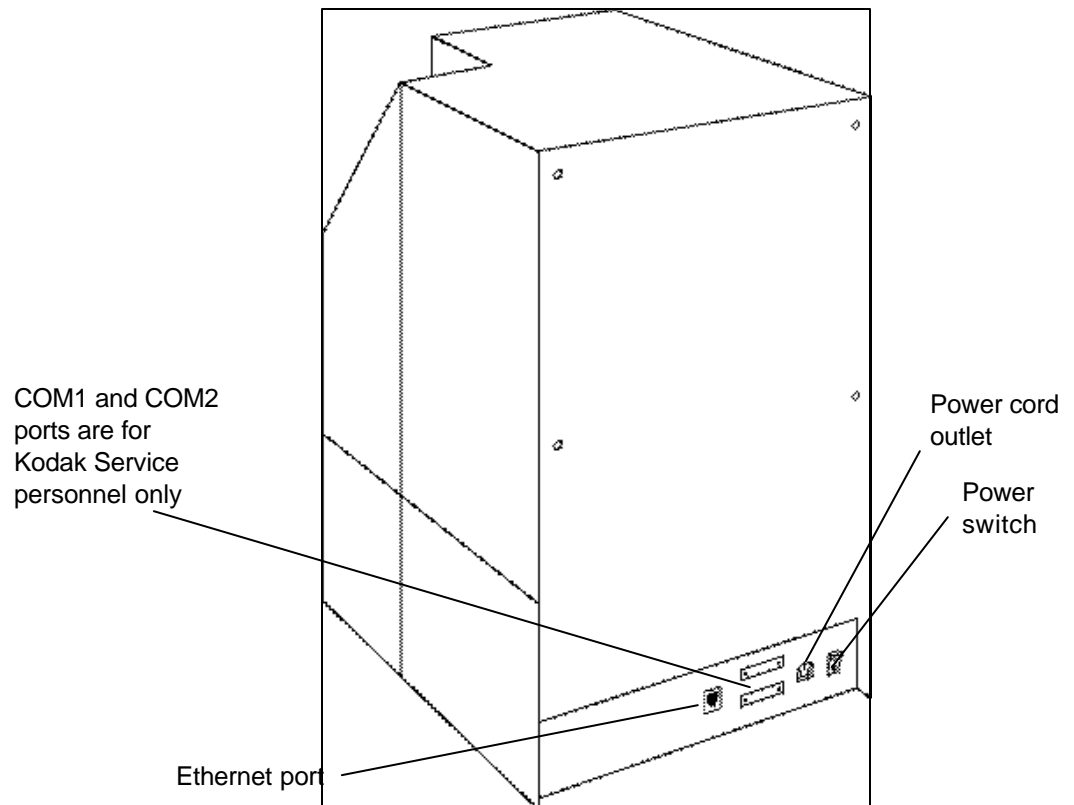

Status/message display

A sample display screen, including operating key labels, is shown below. The label for each key will change depending upon the function being performed.

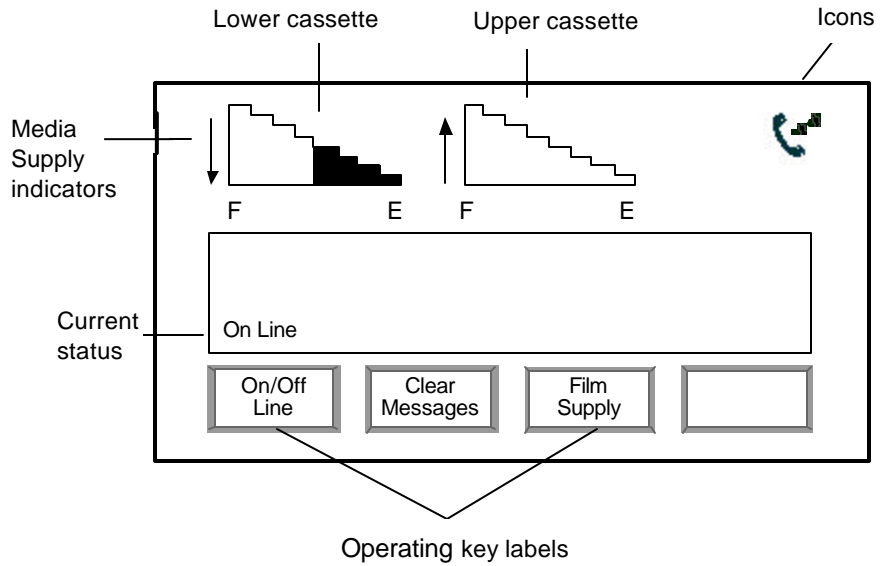

NOTE: The icons that appear on the display are described in Chapter 3, *Operating the Writer*.

2 Getting Started

This chapter provides you with instructions on how to do the following:

- Turn on the power to the Writer.
- Load the media into the cassette(s).
- Load the cassettes into the Writer.

Powering up and initializing the Writer

To power up and initialize the Writer:

1. Place the power switch (located in the back of the Writer) in the On (|) position. When the Writer is powered on, the *Kodak* logo is displayed.

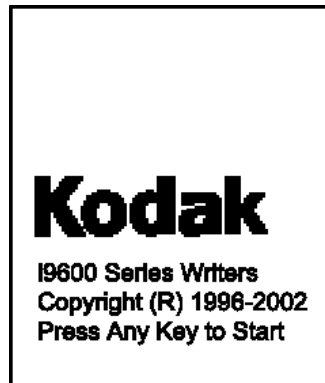

NOTE: Upon initialization, the Writer downloads its operating software from the host PC. Therefore, the host PC connected must be up and running before pressing any key to start.

2. Press any key. The display backlight will turn on, and after a brief pause for system initialization, the Main Menu will be displayed.

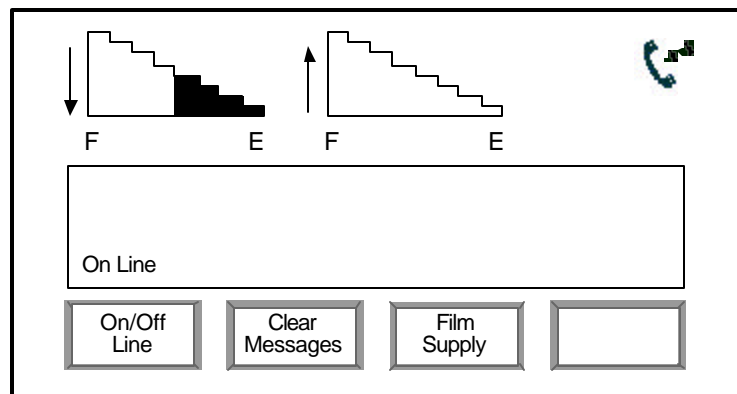

NOTE: After 15 minutes of inactivity the backlight is turned off. To turn the backlight on, press any key on the operator control panel.

Archive storage media cassettes

One or two cassettes are loaded with the media and inserted into the Writer when filming images.

IMPORTANT: *The i9600 Series Writer uses **Kodak** Reference Archive Media. The 215-foot media is loaded into a **Kodak Imagelink** Smart Cassette 215. The 100-foot media is loaded into the **Kodak Imagelink** Smart Cassette 100. Before you begin, be sure you are using the correct media in the proper cassette.*

The following illustrations and descriptions will assist you in locating and becoming familiar with the media cassette components and displays:

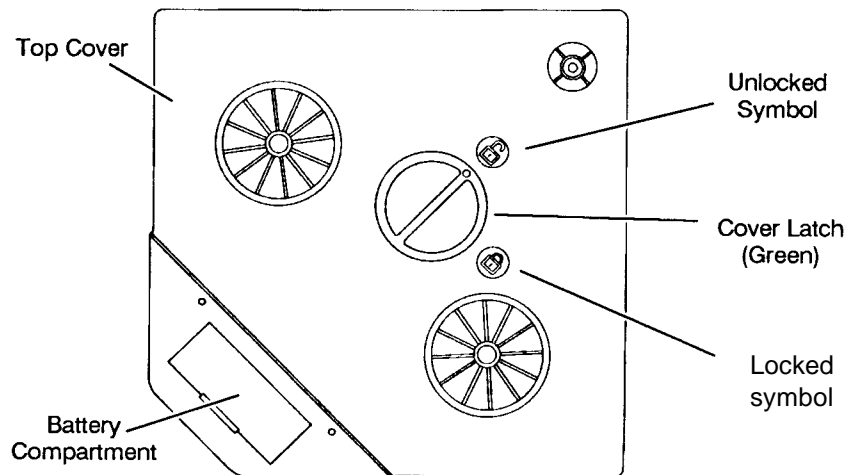

Battery Compartment — contains a 9-volt battery.

Top Cover — provides a light-tight seal to prevent fogging/exposure of the media.

Unlocked Symbol — indicates the unlocked position of the cover latch.

Cover Latch — used to lock or unlock the top cover.

Locked Symbol — indicates the locked position of the cover latch.

Each cassette contains a window that displays graphic symbols representing the media/cassette status conditions:

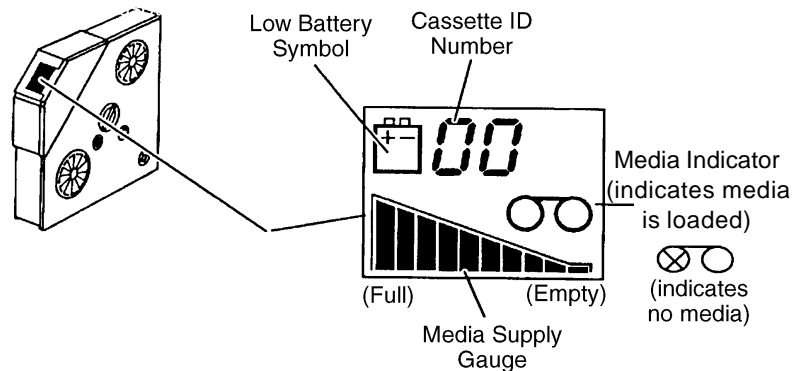

Cassette ID Number — *this feature is not currently supported.*

Media Indicator — indicates whether or not a spool of media is correctly loaded into the cassette.

Media Supply Gauge — using a series of 10 bars, the gauge incrementally indicates the amount of media remaining in the cassette. When all bars are shown, the cassette is full. When no bars are shown, the cassette is empty. When a striped pattern is shown, a new roll of media has been loaded into the cassette, but the media has not been advanced yet while having the cassette loaded into a Writer.

Low Battery Symbol — indicates the battery needs to be replaced immediately.

NOTE: If the cassette you are loading into the Writer is a new cassette or a cassette that has had a dead battery for a long period of time, you will have to update the cassette memory. See the section entitled, "Updating the cassette memory", later in this chapter.

Loading media into a cassette

IMPORTANT: *Always load and unload the media in subdued, indirect light to help prevent "fogging."*

1. Select *Kodak Reference Archive Media* of the desired length, and the corresponding cassette.
2. Check the cassette display:
 - Verify that the media supply gauge shows the cassette is empty (no bars).
 - Verify that there is not a low battery symbol. If a low battery symbol appears, or the cassette window is blank, replace the battery (refer to the section entitled, "Replacing the media cassette battery").

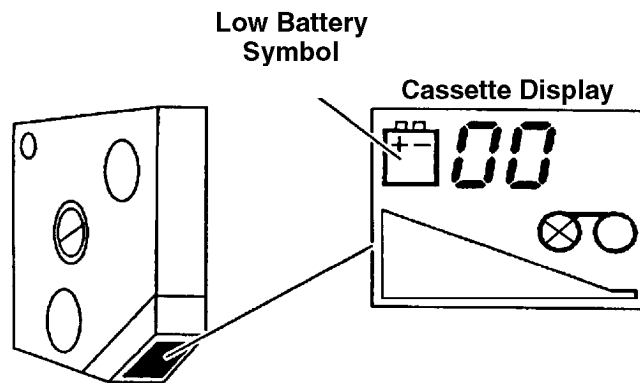

3. Place the cassette on a flat surface with the top cover side up.

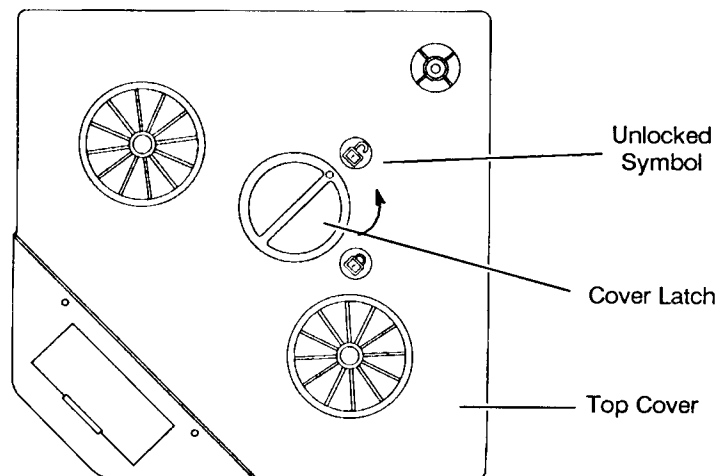

4. Press down on the cover latch and turn counterclockwise to unlock the top cover.
5. Remove the top cover and set it aside.

6. Open a new box of Reference Archive Media and remove the spool of media.

NOTE: Use the empty box to store the exposed media before and after processing.

7. Peel off the paper band from around the spool.
8. Unwind approximately 18 inches (46 cm) of media.

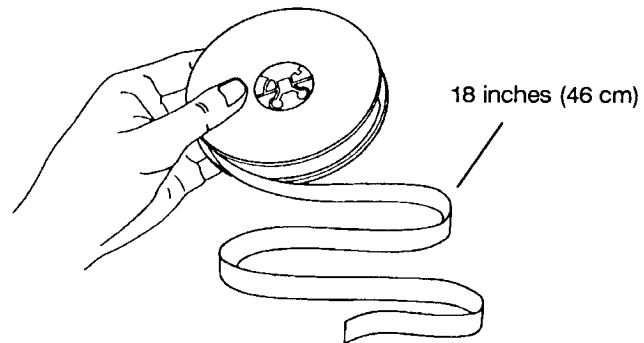

9. Lift the light guard and place the spool of media on the supply spindle with the number 1 side up.

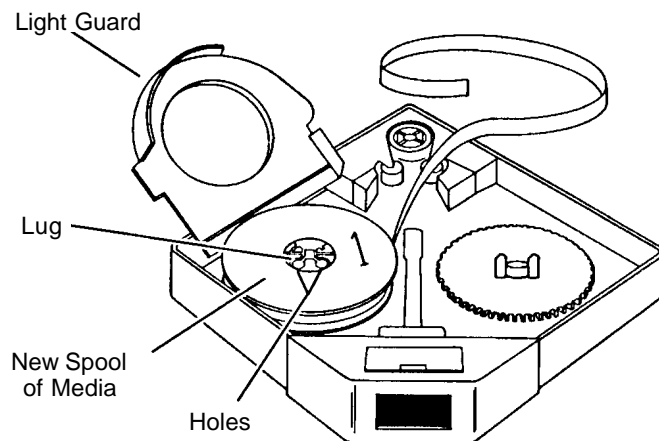

10. Slowly rotate the spool until the two round holes on the spool engage the lugs on the spindle.
11. Lower the light guard.

12. Thread the media around the guide roller, drive roller, and idler roller, following the path indicated by the threading arrows inside the media cassette.

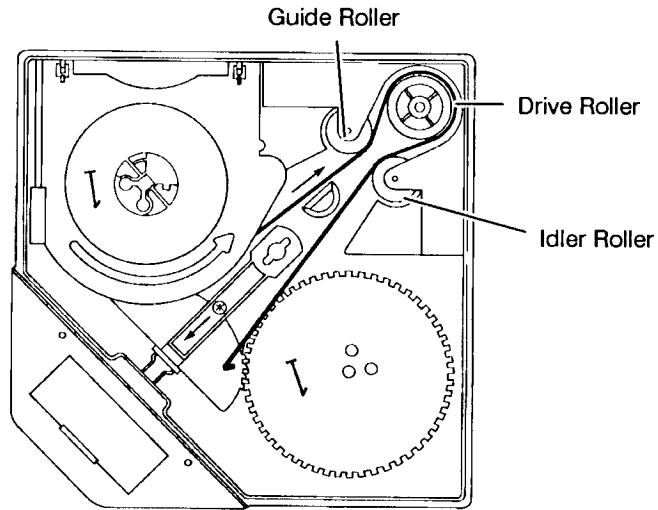

13. Fold back approximately 1/2 inch (1 cm) at the end of the media.

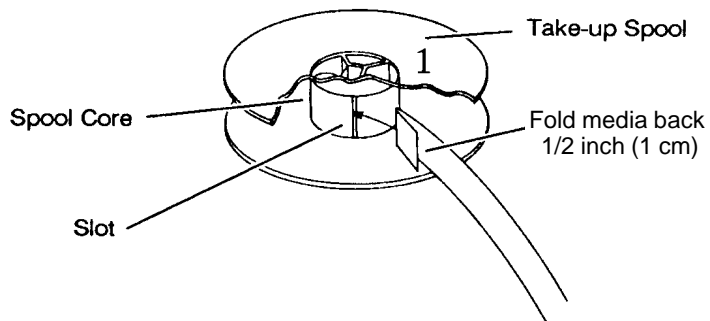

14. Pick up the take-up spool and hold it with the number 1 side up.
15. Insert the folded end of the media into the slot in the take-up spool core.
16. Rotate the spool counterclockwise to secure the media on the spool.

17. Place the take-up spool over the take-up spindle lugs.

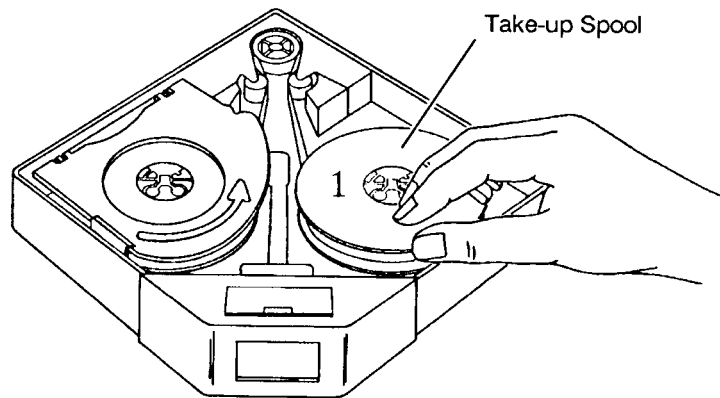

18. Slide the release lever toward the battery compartment and hold it in this position.

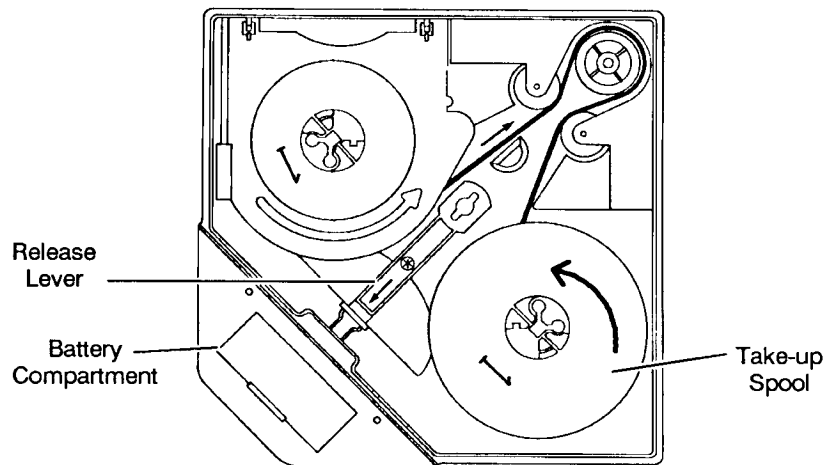

19. Slowly rotate the take-up spool counterclockwise three complete turns to secure the media onto the spool. Allow the release lever to return to its normal position.

20. Replace the top cover. Press down on the cover latch and turn it clockwise to lock the top cover in place.

NOTE: If the media has been properly loaded, the media supply gauge will change to the striped pattern to indicate a new roll of media has been loaded.

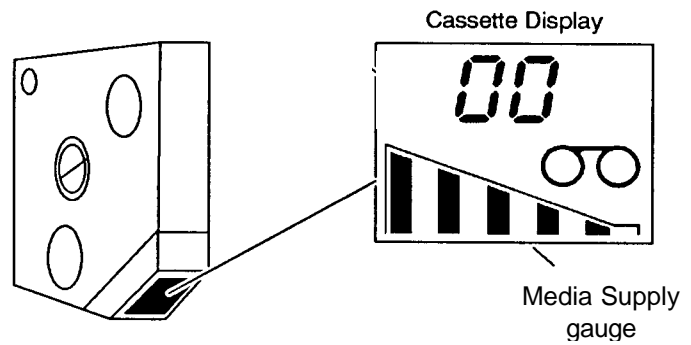

Loading cassette(s) into the Writer

A cassette can be loaded into either the upper or lower slot of the Writer, or both. When two cassettes are loaded, images are written simultaneously to both rolls providing an instant duplicate.

NOTE: If the cassette you are loading into the Writer is a new cassette or a cassette that has had a dead battery for a long period of time, you will have to update the cassette memory. See the section entitled, "Updating the cassette memory", later in this chapter.

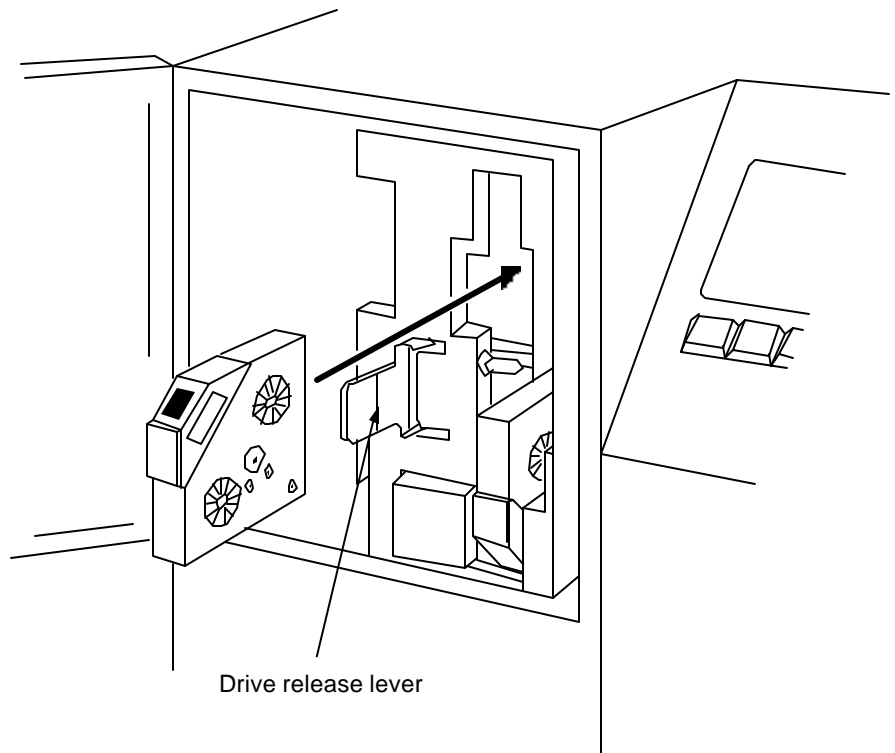

1. Place the Writer in the off-line mode.
2. Open the cassette access door.
3. Swing the drive release lever (green handle) out.
4. Insert the cassette(s).

NOTE: **Refer to the label on the inside of the cassette access door for cassette orientation.** The display window on the cassette is oriented differently depending upon the slot being used.

4. Swing the drive release lever back into place.
5. Close the cassette access door.

Whenever a new or partial roll of media is loaded into the Writer, a leader is automatically made when the cassette access door is closed if the Writer has been powered up and initialized.

A media advance symbol () will appear in the Writer status display while the leader is being advanced. Once the leader has been made, check the media supply indicators on the status display to determine if you have enough media to complete the job.

Updating the cassette memory

To update the cassette memory:

1. Open and close the top cover of the film cassette.
2. Place the Writer in the off-line mode and open the cassette access door.
3. Swing the drive release lever (green handle) out.
4. Insert the cassette.
5. Swing the drive release lever back into place.
6. Close the cassette access door. The Writer will perform a film advance and update the cassette memory and media supply indicator.
7. Place the Writer in the on-line mode.

Replacing the media cassette battery

The cassette battery should be replaced whenever a low battery symbol appears in the cassette display or when the cassette window is blank.

NOTE: For maximum battery life, keep the top cover side of the cassette covered when the cassette is not in the Writer or store cassettes in a low light area.



CAUTION: Replace the battery with a 9-volt alkaline or lithium model U9VL from Eastman Kodak Company or Ultralife Batteries Inc. only. Use of another lithium battery may present a risk of fire or explosion. Disposal of alkaline batteries is not regulated. Users should discard spent alkaline batteries in the municipal trash, unless their community offers a battery recycling program. Disposal of lithium batteries may be considered a hazardous waste under the US EPA's Resource Conservation and Recovery Act (RCRA). Dispose of used batteries according to local, state, and federal regulations.

Never put a battery in your pocket or any other container that contains loose change or metal objects. If battery contacts touch metal objects, the battery may short circuit, discharge energy, become hot or leak.

To replace the cassette battery:

1. Place the cassette on a flat surface with the battery compartment cover facing up.

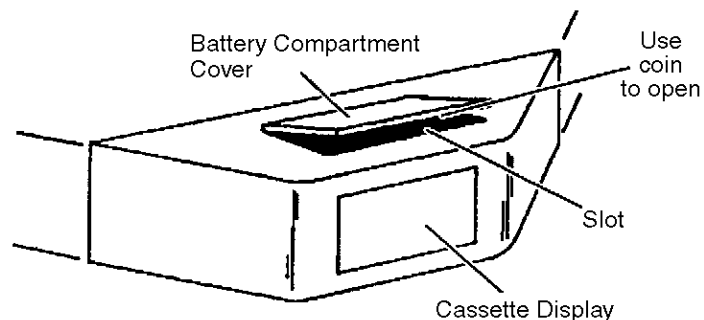

2. Insert the edge of a coin into the slot and carefully pry the battery compartment cover off by pressing down on the coin.
3. Remove the battery compartment cover and set it aside.

4. Lift the battery out and remove the battery contacts from the battery connector. Be careful not to damage the flexible or wire cable.

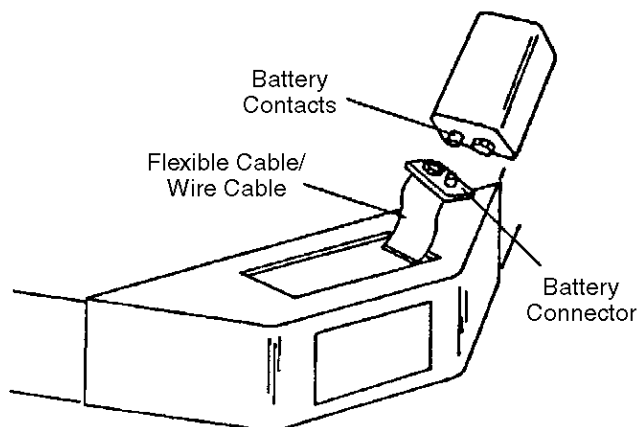

5. Insert the battery contacts of a new battery into the battery connector and lower the battery into the compartment.
6. Replace the battery compartment cover.

3 Operating the Writer

This chapter describes how to use the following functions:

- On-line and off-line modes
- Advancing the film
- Checking the film remaining display
- Viewing the error log
- Setting the audible alarm and screen contrast
- Powering down

Before you begin

NOTE: If the Writer status display is not illuminated, press any key to turn the backlight on.

Operating icons

The following icons may be displayed during operation:



On-line — the Writer is ready to receive information from the host.

No
Icon

Off-line — the Writer is not ready to receive information from the host.



Film Advance — indicates a film motion action is being performed, for example, advancing the film, making a leader, etc.



Hourglass — displayed when the Writer is busy writing images to film. If this icon is displayed, you cannot take the Writer off-line.



Error Symbol — indicates an error message was posted to the error log.

Available functionality

From the operator control panel you can put the Writer on-line or off-line. The following sections describe these modes and the functions available in both modes.

On-line mode

When you are **on-line**, the on-line icon will appear in the upper-right-hand corner. On-line mode primarily allows control of the Writer via the host. Operator control panel functionality is limited. You can:

- View and clear messages
- Check the film remaining
- Put the Writer off-line

NOTE: If the Writer is writing images to film, you will not be able to take it off-line.

Any other functions, such as advancing film, can only be performed in the off-line mode.

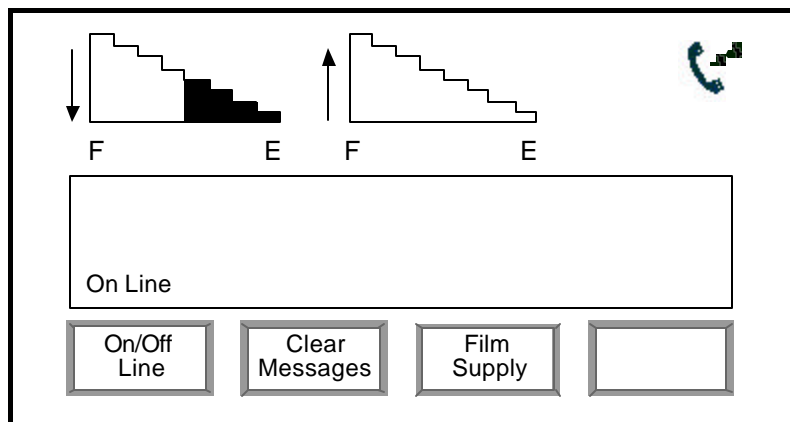

The display shown above is the on-line mode Main Menu.

Off-line mode

When the Writer is **off-line**, the on-line icon will disappear. In the off-line mode you can:

- Advance film (fixed amount, leader, run to end)
- Check the film remaining
- Put the Writer on-line
- View the Error Log
- Set the audible alarm and screen contrast
- Power down the Writer
- Access the Diagnostics menu

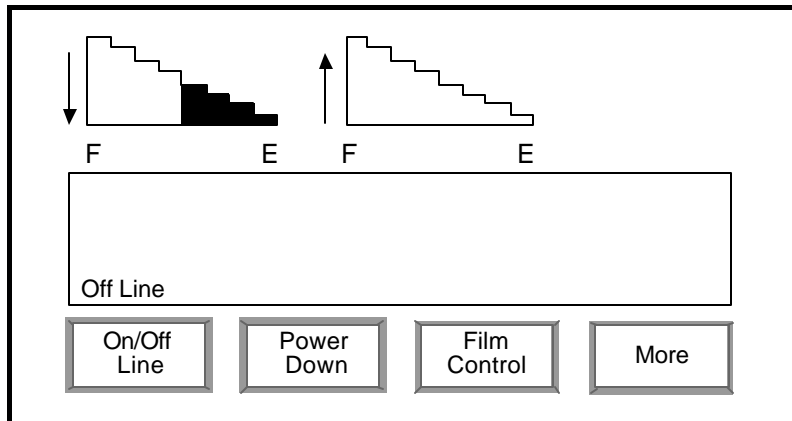

The display shown above is the off-line mode Main Menu.

Using the functions

On-line/off-line

The sections that follow describe how to use the functions available through the operator control panel.

To place the Writer in an on-line or off-line state:

- Press the **On/Off Line** key on the Main Menu. The Writer will toggle between on- and off-line modes.

Advancing the film by a fixed amount

You may advance the film using the Film Advance Length value downloaded and saved from the last application that was used. The default is 1 inch (25 mm). To do this:

1. Place the Writer in off-line mode.
2. Press the **Film Control** key. The following screen will be displayed:

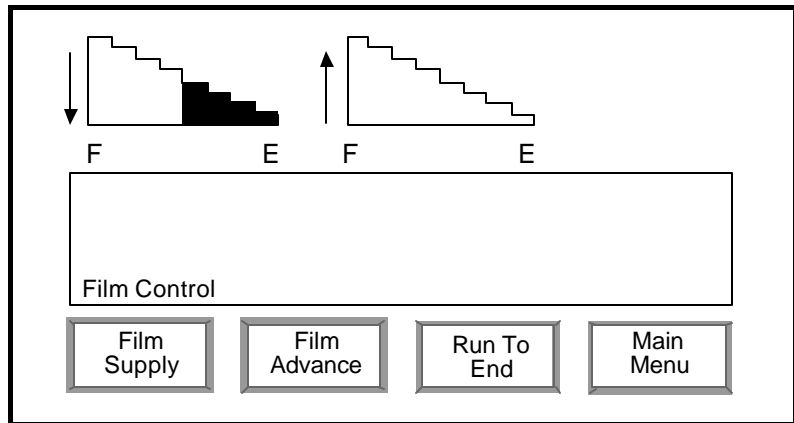

3. Press the **Film Advance** key. The following screen will be displayed:

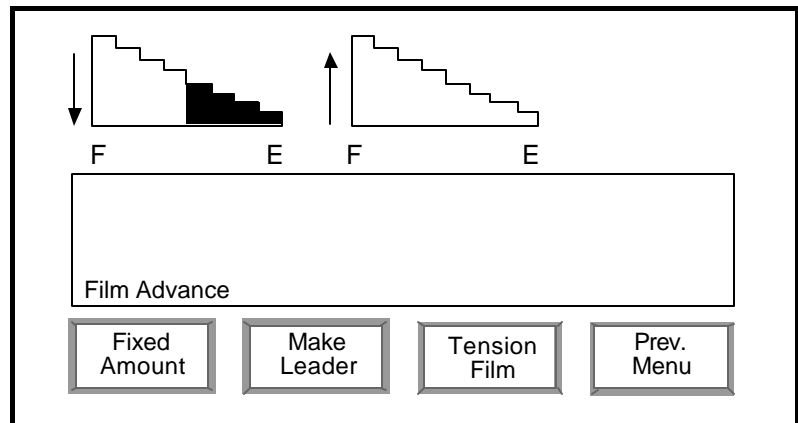

4. Press the **Fixed Amount** key. The Fixed Film Advance screen will be displayed.

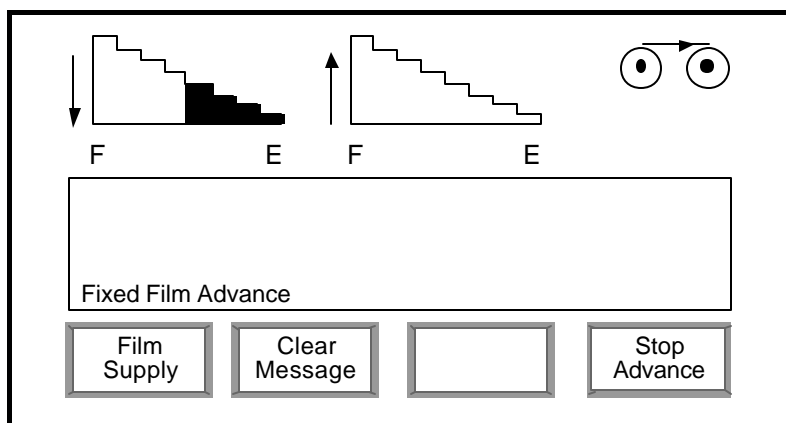

5. The Writer will stop automatically when the programmed amount of film is advanced and the Film Advance screen will be redisplayed. To stop film advance prematurely (i.e., manually), press the **Stop Advance** key.

NOTES:

- If you press the **Film Supply** key, the amount of the film remaining in the upper and/or lower cassette will be displayed on the screen as current units (English=feet/ metric=meters). The media supply indicators also display the amount of film remaining in the cassettes as percentages. For example, 3 bars (|||) would indicate 30% of film remaining.
- Pressing the **Stop Advance** key will stop advancing the film and the Film Advance screen will be redisplayed.
- The Error symbol is only displayed when an error has been posted to the Error Log. If the Error symbol is displayed, you can view the message(s) not previously viewed by pressing the **Clear Message** key. Up to the last ten messages can be viewed on the screen by pressing the **Clear Message** key. If there are more than ten messages, you can view the rest of them via the Error Log screen. For more information, see the section entitled "Viewing error messages" in this chapter.

Making a leader

You may make a leader using the Film Leader Length value downloaded and saved from the last application that was used. The default is 36 inches (91 cm). To do this:

1. Place the Writer in off-line mode.
2. Press the **Film Control** key. The following screen will be displayed:

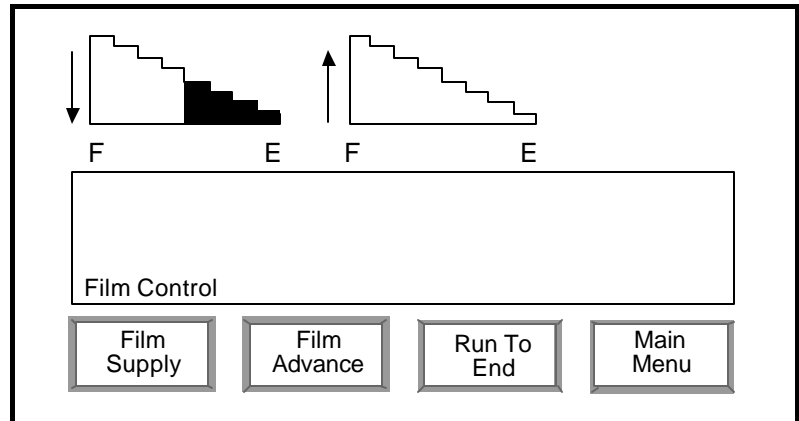

3. Press the **Film Advance** key. The following screen will be displayed:

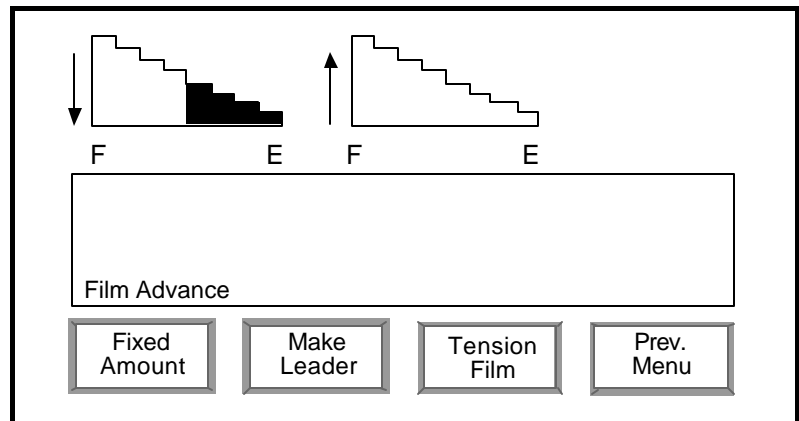

4. Press the **Make Leader** key. The following screen is displayed.

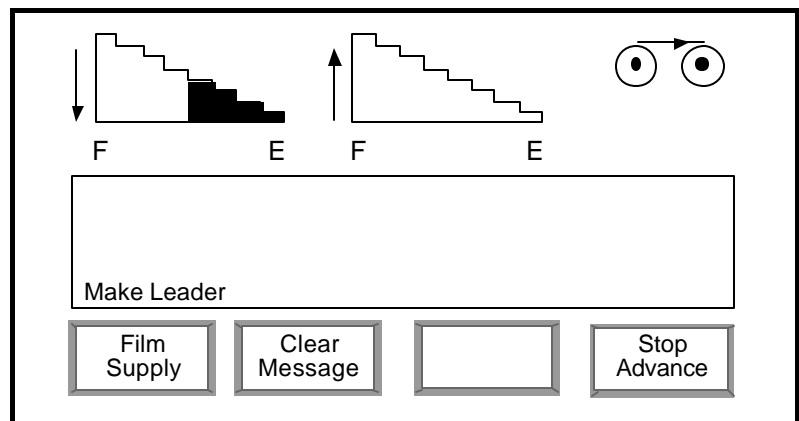

- When a film leader has been generated (or you press the **Stop Advance** key) the Film Advance screen will be redisplayed.

NOTES:

- If you press the **Film Supply** key, the amount of the film remaining in the upper and/or lower cassette will be displayed on the screen as current units (English=feet; metric=meters). The media supply indicators also display the amount of film remaining in the cassettes as percentages. For example, 3 bars (|||) would indicate 30% of film remaining.
- The Error symbol is only displayed when an error has been posted to the Error Log. If the Error symbol is displayed, you can view the message(s) not previously viewed by pressing the **Clear Message** key. Up to the last ten messages can be viewed on the screen by pressing the **Clear Message** key. If there are more than ten messages, you can view the rest of them via the Error Log screen. For more information, see the section entitled "Viewing error messages" in this chapter.

Tensioning the film

You may advance the film using a fixed value of 1 inch (25 mm). To do this:

- Place the Writer in off-line mode.
- Press the **Film Control** key. The following screen will be displayed:

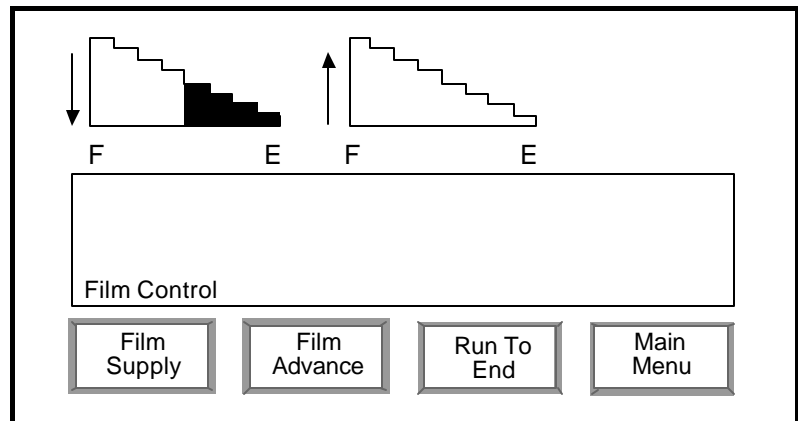

3. Press the **Film Advance** key. The following screen will be displayed:

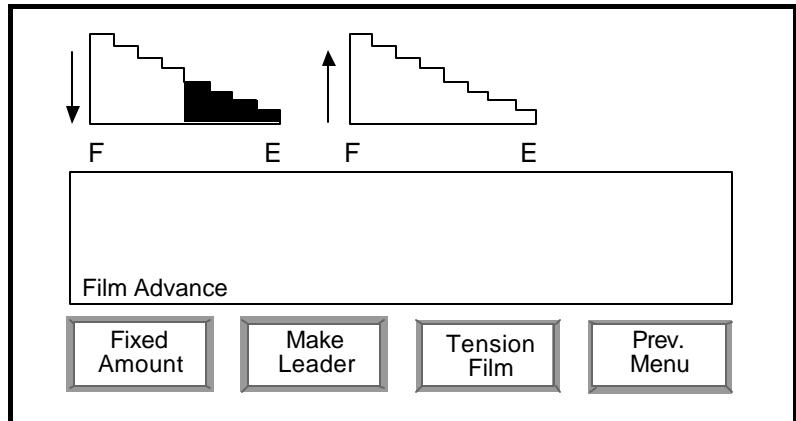

4. Press and release the **Tension Film** key. The Film Advance icon will be displayed for a moment while the film is advanced 1 inch (25 mm).

NOTES:

- You can advance the film by several inches (millimeters) by pressing and releasing the **Tension Film** key as many times as desired until the desired film advance length is reached.
- Pressing and holding the **Tension Film** key for a couple of seconds will place the Writer in continual advance mode. The following screen is displayed.

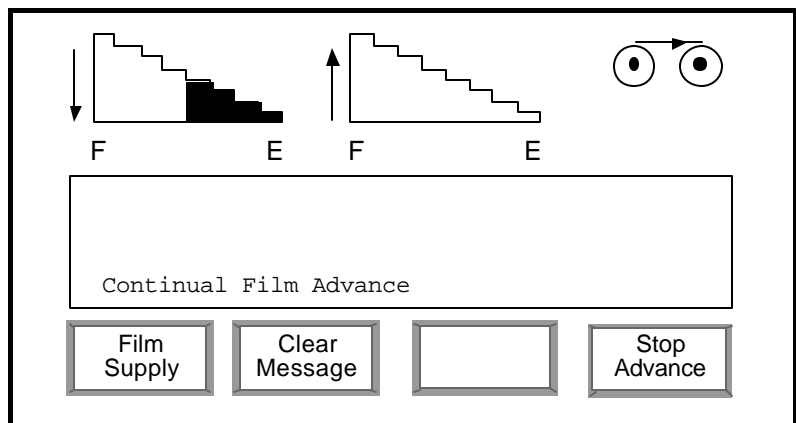

5. Press the **Stop Advance** key when the desired amount of film has been advanced. The Film Advance screen will be redisplayed.

- If you press the **Film Supply** key in continual advance, the amount of the film remaining in the upper and/or lower cassette will be displayed on the screen as current units (English=feet/metric=meters). The media supply indicators also display the amount of film remaining in the cassettes as percentages. For example, 3 bars (|||) would indicate 30% of film remaining.
- The Error symbol is only displayed when an error has been posted to the Error Log. If the Error symbol is displayed, you can view the message(s) not previously viewed by pressing the **Clear Message** key. Up to the last ten messages can be viewed on the screen by pressing the **Clear Message** key. If there are more than ten messages, you can view the rest of them via the Error Log screen. For more information, see the section entitled “Viewing error messages” in this chapter.

Running the film to the end

To run the film to the end:

1. Place the Writer in off-line mode.
2. Press the **Film Control** key. The following screen will be displayed:

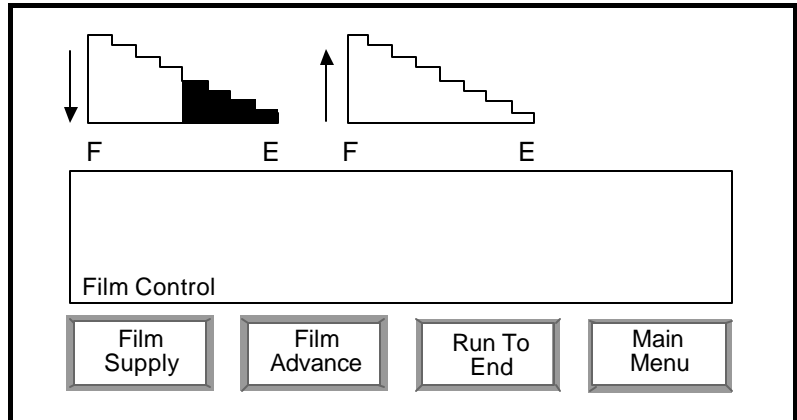

3. Press the **Run To End** key. The film will run to the end of the spool and the status will be incrementally updated on the media supply indicators.

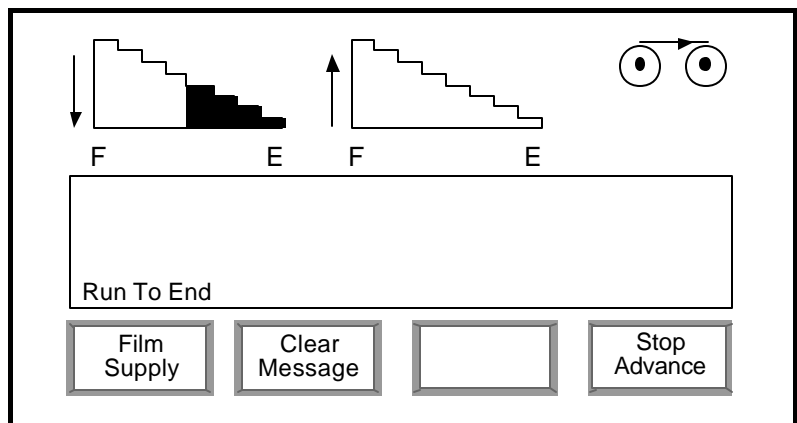

4. When this screen is displayed, you may press the **Stop Advance** key at any time while the film is advancing. When the supply spool runs out of film or the **Stop Advance** key is pressed, the Film Control screen will be redisplayed.

NOTES:

- If you press the **Film Supply** key, the amount of the film remaining in the upper and/or lower cassette will be displayed on the screen as current units (English=feet; metric=meters). The media supply indicators also display the amount of film remaining in the cassettes as percentages. For example, 3 bars (|||) would indicate 30% of film remaining.
- The Error symbol is only displayed when an error has been posted to the Error Log. If the Error symbol is displayed, you can view the message(s) not previously viewed by pressing the **Clear Message** key. Up to the last ten messages can be viewed on the screen by pressing the **Clear Message** key. If there are more than ten messages, you can view the rest of them via the Error Log screen. For more information, see the section entitled "Viewing error messages" in this chapter.

Viewing error messages

The Writer keeps an internal error log, which includes the errors/warnings that have occurred. You can view these errors from the Error Log Display.

The Error Log Display screen provides the option of viewing all errors, or only those errors that have not been viewed. When the error is displayed on the screen, it provides the error number, date, time, and error text.

You can view error messages only when you are in off-line mode. To view error information:

1. Press the **More** key on the off-line Main Menu.

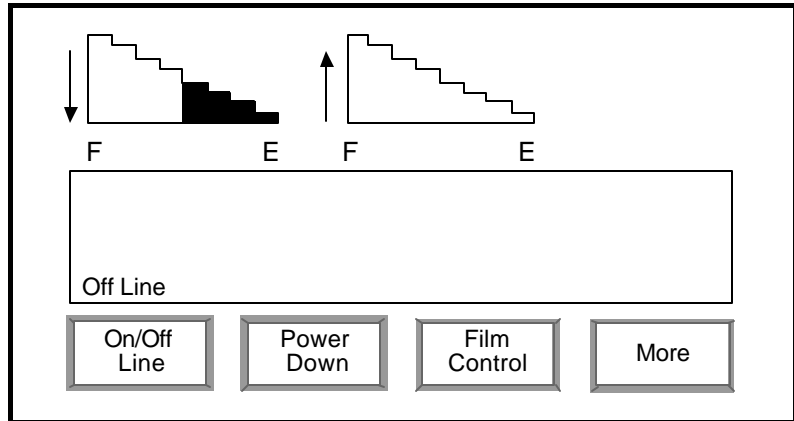

The Additional Functions screen will be displayed. From this screen you can access detailed error information.

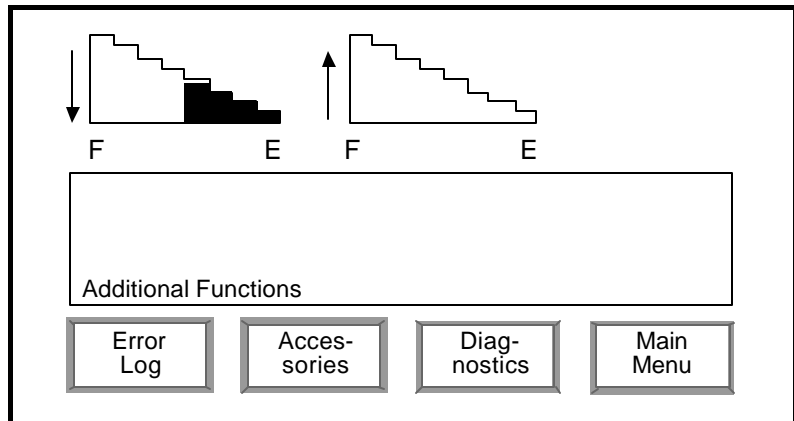

- Press the **Error Log** key. The following screen will be displayed:

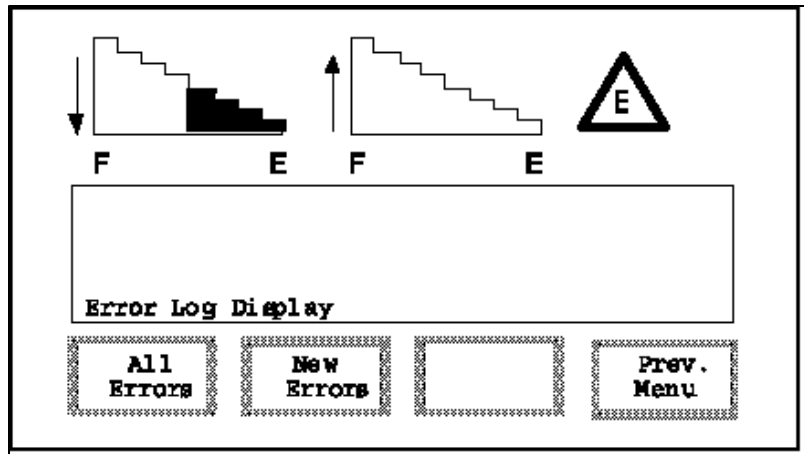

All Errors — displays all the errors in the Error Log. The Error Log can hold up to 200 errors.

New Errors — displays the errors that have not been viewed yet.

To display **All Errors** or **New Errors**:

- Press the desired key. The Error Log will be displayed:

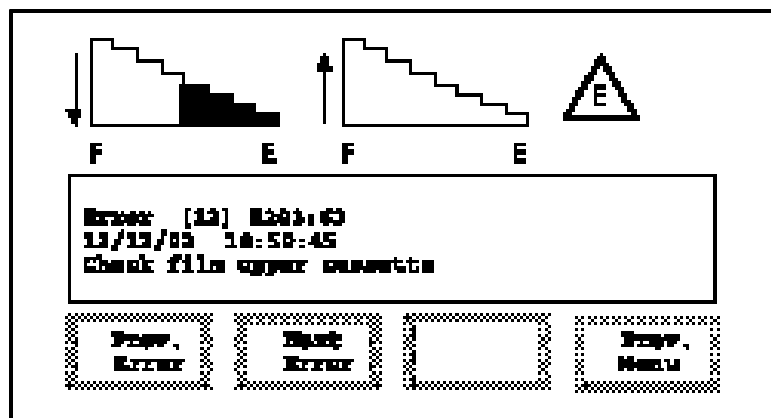

Error Format:

The errors are displayed in the following format:

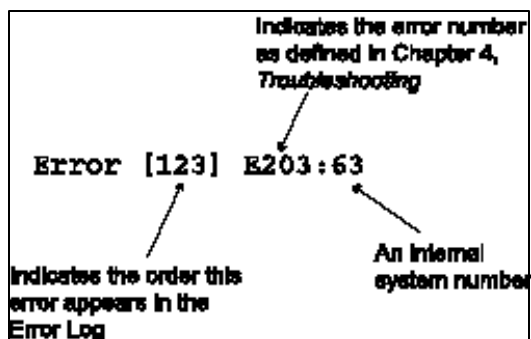

NOTES:

- Only service personnel can clear the Error Log.
- Pressing the **Prev. Error** key will display the error that occurred before the current error. The **Prev. Error** key is only accessible when viewing **All Errors**.
- Pressing the **Next Error** key will display the error that occurred after the current error.
- Pressing the **Prev. Menu** key will return you to the Error Log Display screen.

Setting the audible alarm

To set the volume on the audible alarm.

1. Press the **More** key on the off-line Main Menu.

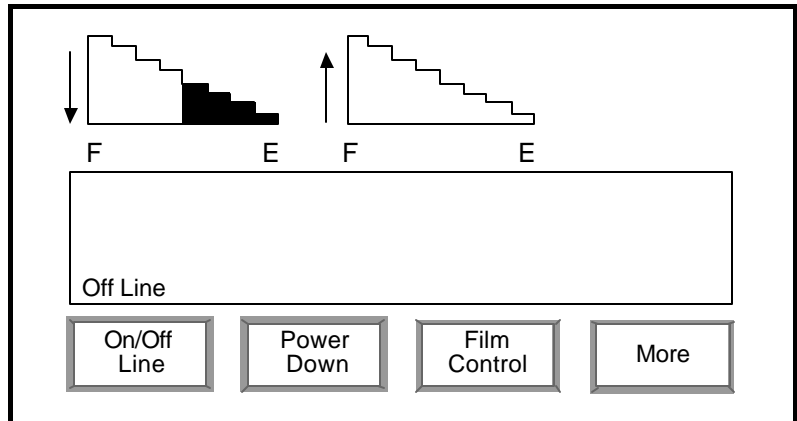

The Additional Functions screen will be displayed. From this screen you can access the Accessories function.

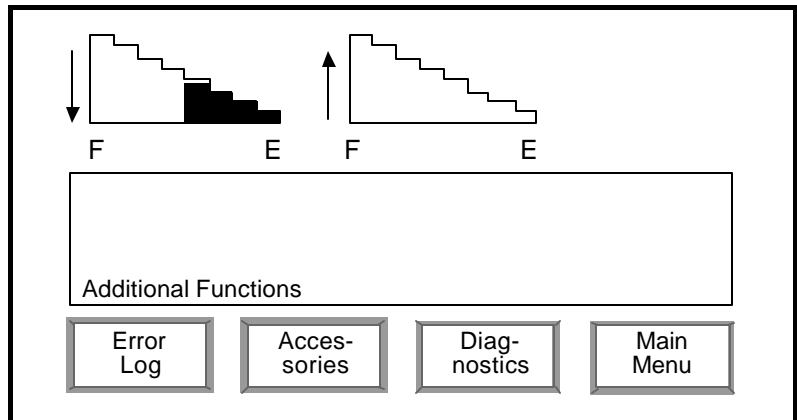

2. Press the **Accessories** key to display the Accessories screen.

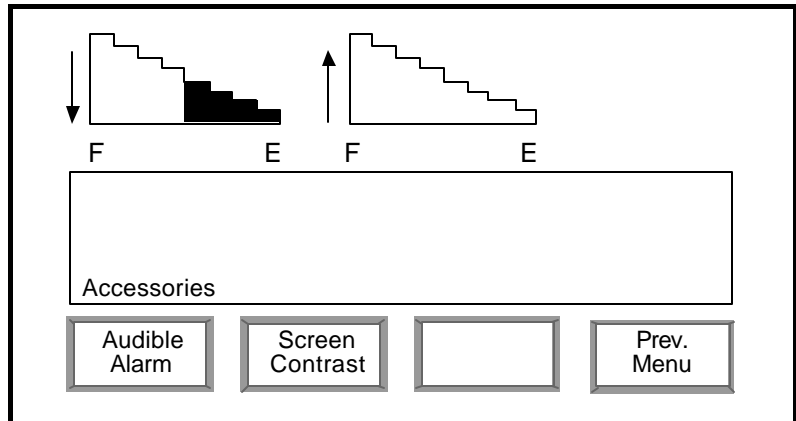

3. Press the **Audible Alarm** key. The Audible Alarm screen will be displayed. From this screen you can set the alarm louder or softer or turn the alarm on or off. The Audible Alarm screen displays whether the alarm is on or off as well as the percentage of the volume.

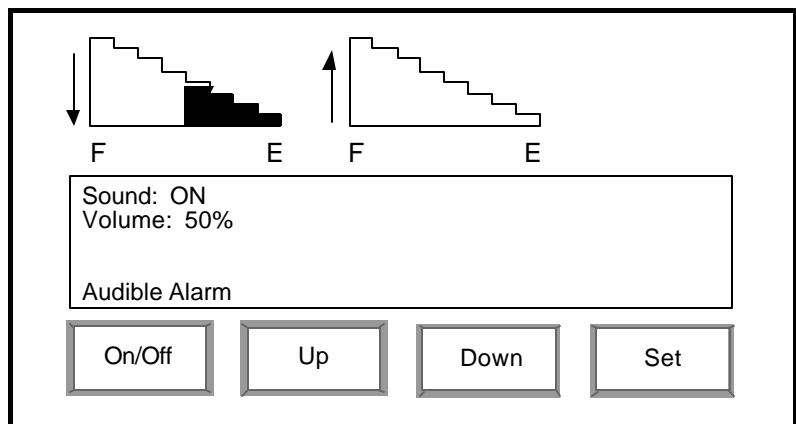

4. Press the **Up** key to turn the alarm up louder or press the **Down** key to make the alarm softer.
5. Press the **Set** key when finished to set your selection and return to the Accessories menu.

To turn the audible alarm on or off:

- Press the **On/Off** key.

Setting the contrast

To increase or decrease the contrast of the screen display on the Writer.

1. Press the **More** key on the off-line Main Menu.

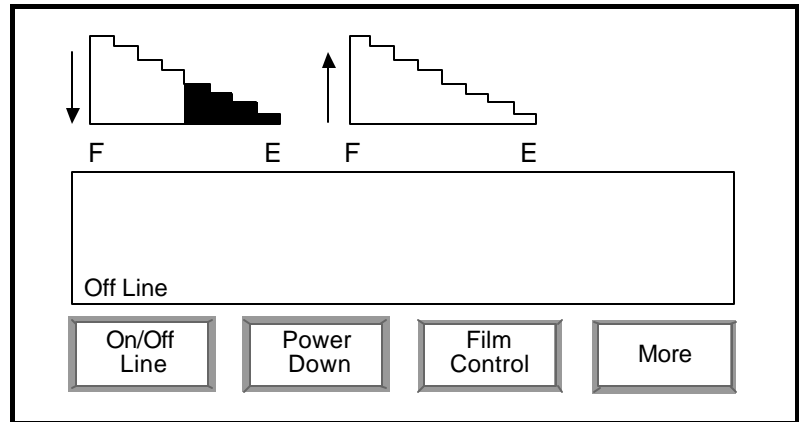

The Additional Functions screen will be displayed. From this screen you can access the Accessories function.

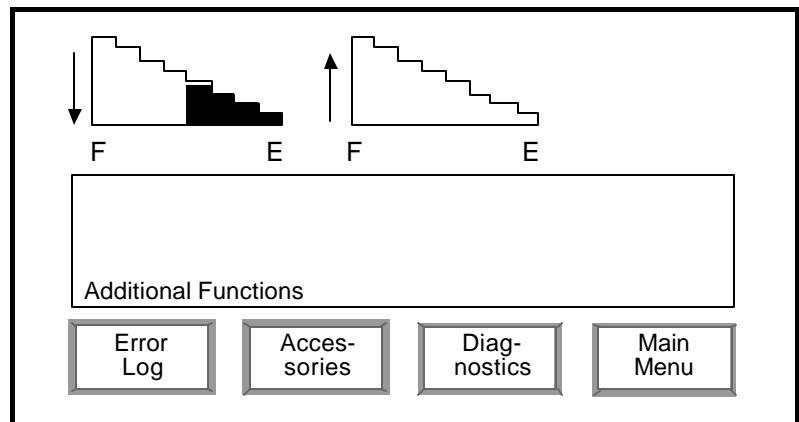

2. Press the **Accessories** key to display the Accessories screen.

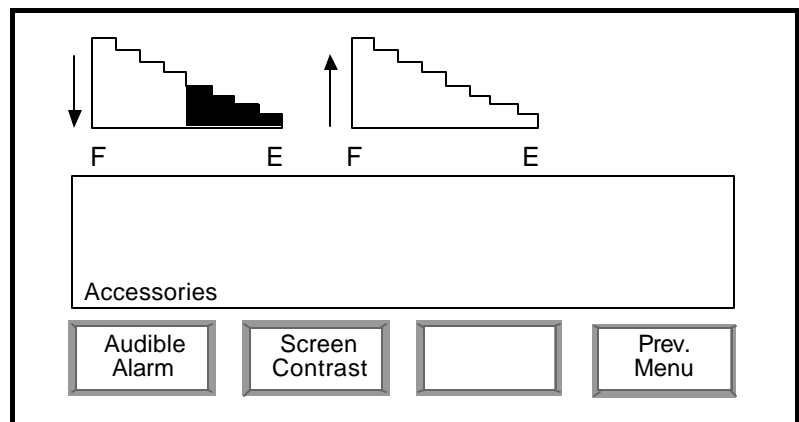

3. Press the **Screen Contrast** key. The Contrast screen will be displayed. From this screen you can increase or decrease the contrast. The Contrast screen displays the setting of the current screen contrast.

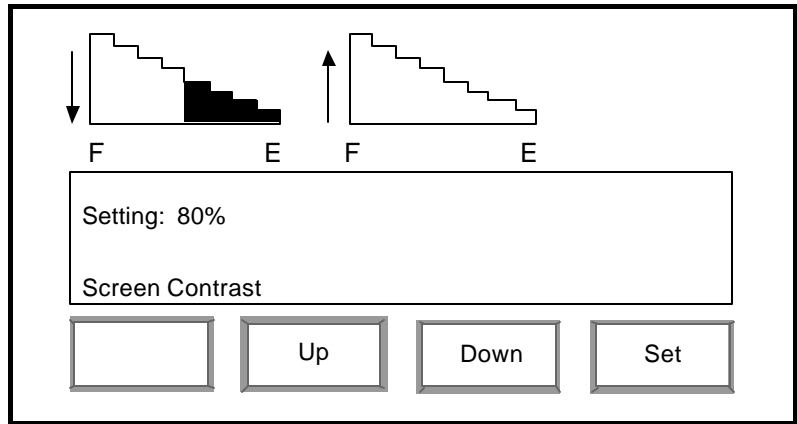

4. Press the **Up** key (makes the display brighter) to increase the contrast setting or press the **Down** key (makes the display duller) to decrease the contrast.
5. Press the **Set** key when finished to set your selection and return to the Accessories screen.

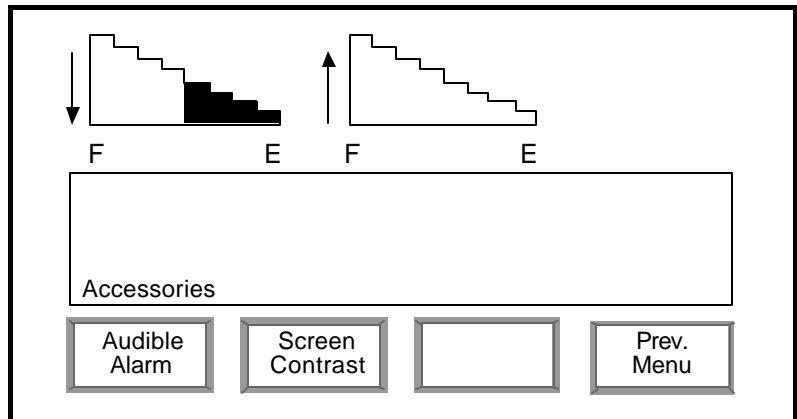

Diagnostics

The Diagnostics function is password-protected and reserved for use by Kodak service personnel. The Diagnostics function is accessed via the **More** key on the off-line Main Menu.

Powering down

You can power down the Writer by selecting the **Power Down** key from the off-line Main Menu.

IMPORTANT: Before turning the power off to the Writer, be sure the last job run has been completed for at least 30 seconds.

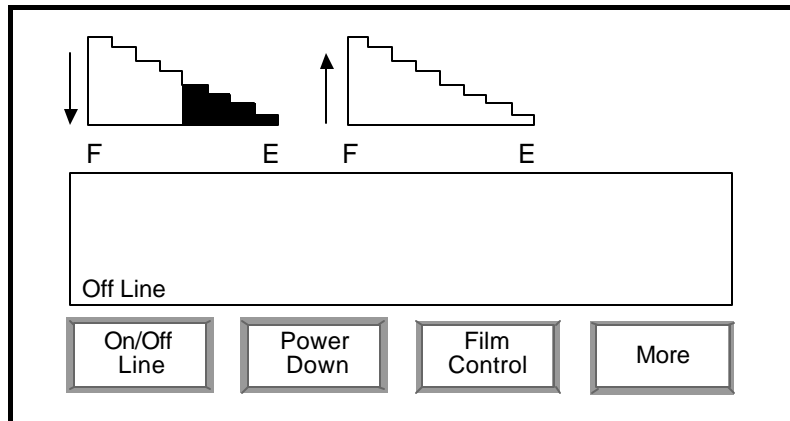

Selecting the **Power Down** key will put the Writer in a “sleep” mode. The **Kodak** screen will be displayed, but the display backlight will be turned off.

To reactivate the Writer when it is in “sleep” mode, press any key.

4 Troubleshooting

Error messages

Following are some common messages and descriptions of error codes you may encounter when using the *Kodak i9600 Series Writer*. Other error codes may occur. If they persist, call your System Integrator or Kodak Service.

103 Cassette door closed

The cassette access door was closed.

200 Check film supplies

The film remaining in the upper cassette is equal to or less than 3 feet (91 cm).

- Place a new roll of film in the cassette.

201 Check film supplies

The film remaining in the upper cassette is equal to or less than 10 feet (3.05 m).

- Place a new roll of film in the cassette.

202 Check film supplies

Check film supplies. The film remaining in the upper cassette is equal to or less than 15 feet (4.55 m).

- Place a new roll of film in the cassette.

203 Check film upper cassette

- Put a new roll of film in the cassette.

204 Check film lower cassette

- Put a new roll of film in the cassette.

205 Check film upper cassette

The film remaining in the upper cassette is equal to or less than 5 feet (1.52 m).

- Place a new roll of film in the cassette.

206 Check film lower cassette

The film remaining in the lower cassette is equal to or less than 5 feet (1.52 m).

- Place a new roll of film in the cassette.

207 Upper cass battery low

- Replace the battery in the upper cassette.

208 Lower cass battery low

- Replace the battery in the lower cassette.

209 Replace upper cass battery

- Replace the battery in the upper cassette. If the problem persists, call Service.

210 Replace lower cass battery

- Replace the battery in the lower cassette. If the problem persists, call Service.

211 Close cassette door

- Close the door.

212 Rotate upper cassette

The upper cassette was inserted improperly.

- Turn the cassette over.

213 Rotate lower cassette

The lower cassette was inserted improperly.

- Turn the cassette over.

221 Check film supplies

The film amounts between the upper and lower cassettes differ by more than 6 feet (1.83 m).

- Remove the cassette with the smaller amount and advance a leader on the other cassette, or ignore the error message.

222 Verify image address

The image addresses in the upper and lower cassettes are different.

- Reset the image addresses to match (through the host application).

223 Verify roll number

The roll number in the upper and lower cassettes are different.

- Reset the roll numbers to match (through the host application).

224 Insert matching cassettes

The upper cassette is on side 1 and lower cassette is on side 2.

- Insert two identical cassettes.

225 Insert matching cassettes

The upper cassette is on side 2 and lower cassette is on side 1.

- Insert two identical cassettes.

228 Insert missing cassette

The upper cassette is missing.

- Insert the upper cassette into the film unit.

229 Insert missing cassette

The lower cassette is missing.

- Insert the lower cassette into the film unit.

231 Check host

Cannot process tiled images.

- Reformat image as a single-strip image instead of tiled; resend image.

232 Check host

Cannot process Group 4 multi-strip images.

- Reformat image for Group 4 single strip; resend image.

237 Check host

- Verify that the image is valid and conforms to the TIFF specification.

240 Check host

Image composition scaled image too long.

- Rescale image to fit in available space; resend image.

241 Check host

Image composition scaled image is too wide for frame.

- Rescale image to fit in available space; resend image.

246 Check host

Image composition invalid image scaling factor.

- Resend the image with valid data.

255 Check host

Invalid image address format.

An invalid image address format was received from the host.

- Restart the job. If the problem persists, call your system integrator.

256 Check host

Invalid image address data.

An invalid image address was received from the host.

- Restart the job. If the problem persists, call your system integrator.

257 Check host

Address field overflow.

An image address field overflow occurred.

- Restart the job. If the problem persists, call your system integrator.

258 Check host

Address field too wide.

An invalid image address field specification was received from the host.

- Restart the job. If the problem persists, call your system integrator.

259 Check host

Image address length too long.

The image address received from the host is too long.

- Restart the job. If the problem persists, call your system integrator.

260 Check host

Incompatible image address format.

An invalid image address format was received from the host.

- Restart the job. If the problem persists, call your system integrator.

261 Check host

Invalid number of address fields.

An invalid number of image address fields were received from the host.

- Restart the job. If the problem persists, call your system integrator.

262 Check host

The Writer was unable to read the language file.

The Writer is cannot read the language file specified by the host.

- Restart the job. If the problem persists, call your system integrator.

263 Check host

The requested power-down interval was invalid.

- Enter a valid interval.

266 Check host

While the Writer was off-line, a command was received from the host that is not valid in the off-line mode.

- Place the Writer on-line.

267 Check host

A command was received after the Writer reported a critical error, but before the error was corrected.

- Clear the critical error.

268 Check host

A command was received after the Writer reported a correctable error, but before the error was corrected.

- Clear the correctable error.

269 Check host

A command was received after the Writer reported a warning, but before the warning was corrected.

- Clear the warning error.

273 Verify Writer Film Upper Cassette

A cassette is inserted in the upper film bay of the Writer that has not been previously used. It is possible that the cassette is an IL30/70 cassette.

- Verify that the cassette inserted in the upper film bay is the proper cassette.
- Verify that the Writer film is in the upper cassette.
- Verify that the cassette was not used with a dead battery; replace the battery.

274 Verify Writer Film Lower Cassette

A cassette is inserted in the lower film bay of the Writer that has not been previously used. It is possible that the cassette is an IL30/70 cassette.

- Verify that the cassette inserted in the lower film bay is the proper cassette.
- Verify that the Writer film is in the lower cassette.
- Verify that the cassette was not used with a dead battery; replace the battery.

278 Check host

Invalid image composition scaling parameter.

An invalid image scaling value was received from the host.

- Restart the job. If the problem persists, call your system integrator.

Problem solving chart

Use the chart below as a guide to check possible solutions to problems you may encounter when using the *Kodak i9600 Series Writer*.

Problem	Possible Solutions
The <i>Init Please Wait</i> message is displayed for more than 3 minutes.	<ul style="list-style-type: none">• Check that the host PC is powered on.• Check to see if the network cable from the Writer is securely connected to either the host PC (if you are directly connected to the host) or to your local network (if not directly connected).• Remove all cassettes from the Writer and reboot.• There may be a problem with the Writer attaching to the server and downloading the firmware from the host. Refer to the Reference Card for the <i>Kodak i9600 Series Writer</i>, A-61060. <p>If the problem persists, call Service.</p>
The screen on the Writer is too light or too dark.	Adjust the contrast setting. See the section entitled, "Setting the contrast" in Chapter 3.
Images appear wavy on the processed film.	The Writer may have been inadvertently jarred during film writing. Be sure the Writer does not rock on an uneven floor. Consider moving the Writer to a location where it will not be jarred.
The alarm is too loud or too soft.	Adjust the volume setting. See the section entitled, "Setting the audible alarm" in Chapter 3.
Intermittent non-reproducible errors displayed during archiving.	The battery may be low in the cassette. Replace the battery.
The Writer is not available in the selection list in the application software.	<ul style="list-style-type: none">• There may have been a problem which caused the Writer to be marked as <i>Unavailable</i> in the software. If the Writer is booting correctly, view the Writer from within the application software (this should clear the <i>Unavailable</i> status). Return to the application software to see if the Writer is now <i>Available</i>.• Be sure the Writer is in the on-line mode.

EASTMAN KODAK COMPANY
Document Imaging
Rochester, New York 14650

Kodak and Imagelink are trademarks of Eastman Kodak Company.

Printed on recycled paper.

A-61058 1/03
CAT No. 134 1759
©Eastman Kodak Company, 2003
Printed in U.S.A.

**DOCUMENT
IMAGING**

